

AUCKLAND SOCIETY OF MODEL ENGINEERS INCORPORATED

PETERSON RESERVE, PANMURE, AUCKLAND
PO BOX 14570, PANMURE, AUCKLAND 1741, NEW ZEALAND

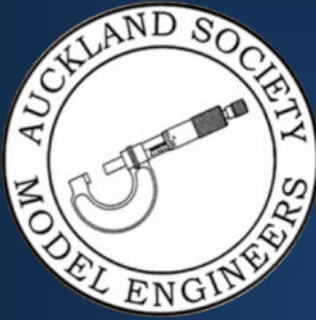

Club House Telephone
(09) 570 5286

Club Web Site
www.asme.org.nz

President
Grant Anderson
Phone: 027 481 0185
E-mail address president@asme.org.nz

Secretary
David Russell
Phone: 09 446 0957
E-mail address info@asme.org.nz

Editor
Hayden Purdy
Email addresses
editor.asme@gmail.com
editor@asme.org.nz

AUGUST 2011
NUMBER 560

THE MICROMETER

REGISTERED NEW ZEALAND PUBLICATION

In This Issue:

- Page 2.....Train Roster
- Page 3.....Club Calendar
- Page 3-5.....President's Report
- Page 6-9.....Bits and Pieces
- Page 10-11.....Latest in Engineering
- Page 11-13.....Around the Clubs
- Page 13.....Classifieds
- Page 14-15.....Casting Operations
- Page 16.....Notes From The Editor's Desk



A Komatsu 575 - The world's largest & most powerful bulldozer. (*Note man leaning on blade arm*)

Train Roster

Date	Electric	Electric	Steam	Station	Station	Station	Extra Guard #
7 th August	D Housley	J McManus	<u>L Farquhar</u>	P Haycock	G Healy*	P Jones	
14 th August	P Moy	A Murley	<u>M Jack</u>	G Kemp	J Lankow*	D Leybourne	
21 st August	T Robinson	I Ashley	<u>T Lawrence</u>	M Luxton	I Lyons	H Martin*	
28 th August	P Woodford	D Black	<u>M Orange</u>	S Meikle*	C Mitchell	D Moffatt	
4 th September	D Booth	B Cotton	<u>B Piggot</u>	G Murray	J Olsen*	W Parker	
11 th September	T Crake	P Eaton	<u>A Pritchard</u>	G Quayle*	R Reichardt	M Richardson	
18 th September	M Granger	R Hannah	<u>D Russell</u>	K Ryan*	A Shirley	R Smith	
25 th September	J Harrison	P Haycock	<u>G Wills</u>	R Stratton	R Street	T Taylor*	P Dowdeswell

Bold and Underlined name:

This is the designated **Train Controller**, i.e. the person in overall control of all operations for the day.

If you are the **Train Controller** you should phone around the others rostered for that day to make sure they remember to turn up.

Bold with Asterisked* name :

This is the designated **Stationmaster**, i.e. the person responsible for activities in the station area for the day. The Stationmaster is also responsible to account for the day's takings.

Please Note, there is no expiry period or date on train ride tickets previously sold.

Please Note:

On your rostered day you should arrive by 12.45pm to get prepared for the days running. If for some reason you are unable to fill your rostered date, you are respectfully reminded that it is your responsibility to find a replacement member to fill the gap - please don't let the rest of the team for the day be left "short-handed".

Club Calendar

ASME Events	
2 nd August	General Meeting, Peter Woodford will show his workshop practice video on Foundry work.
9 th August	Committee Meeting.
16 th August	Workshop Night, at the clubrooms.
6 th September	General Meeting.
10 th September	Workshop visit to members workshops in Waiuku (meet at clubrooms 12.00 for car-pooling).
8 th - 9 th October	ASME annual exhibition and judging of exhibits, start getting your exhibits ready. A big thanks to Bill Parker and Hayden Purdy for offering to co-ordinate the event.
13 th October	Committee Meeting
10 th December	ASME Annual Dinner and awards presentation.
General Events	
8 th & 9 th October	Puffing Billy Railway Gala, Victoria, Australia
26 th November	Glenbrook Vintage Railway open invitation to like minded clubs, ride by donation, a great day for all. The day starts at 1pm at Glenbrook Station
5 th - 9 th Jan 2012	International Convention, Whangarei

Presidents Report

August 2011

The presentation of the Track and Trolley survey results by David Black at the July general meeting provided food for thought for the Club and some direction for the Committee as to what should happen next. The Committee is working on this matter which is very important for the future of our Club and members will be advised as soon as the matter has been fully considered and a decision made. There will still need to be an appropriate resolution passed at a properly convened meeting of members before any changes occur.

We had a good turnout of members at Manukau Live Steamers on their "small gauge" day and enjoyed their facilities and the great catering that MLS provided – thank you. Our next fun run will be at the ASME track on 17th September from 1pm.

Again this month you will receive an email copy of the Micrometer (sent to all members for whom we have a correct email address). We trust you will be enjoying these full colour versions and see the benefits of this method of delivery. A paper copy will still be sent as well (other than to those who have requested email only), for this issue and finally for the September issue. Please be asking yourself – do you really need a paper copy each month or would the email version alone suffice? For those who do not have email or who really do want the Club to continue to supply a paper copy, the committee has decided that you will need to let the Secretary know **in writing** before 31 August 2011 of your requirements; otherwise the default position will be an email copy only after the September issue. This move is focused on making significant savings on what has become the single largest expense of running our Club.

For those who are not on email or who did not get to the July general meeting, I repeat the information that a past member who was active in attending general meetings for many years, Terry Appleton, passed away late last month.

The September workshop visit will be a little different in that it will be held on a Saturday afternoon when we will travel out to Waiuku to visit the workshops of two of our members who live in that area (Bill Parker and Greg Burrows). It is proposed that we meet at the Clubrooms not later than 12 noon for carpooling and travel as much as possible in full car loads to keep travel costs down. The rough timetable is to leave the Clubrooms shortly after 12 noon, arrive at Bill's at 1pm, move onto Greg's about 2.30ish, leaving about 4.30 and arriving back to the Clubrooms by 5.30pm. Feel free to travel directly if that suits best; addresses are as in the last circulated membership list. Please think about whether you want to make it along on this visit so that we can give our hosts an idea of numbers at the September general meeting.

Please welcome new member Reuben Yu, a young lad from Bucklands Beach who has joined our Club. Reuben has an interest in small railways and has attended several meetings with his Dad, Daniel. Already Reuben has brought some items along to show at "Bits & Pieces". While on membership, I advise of the resignation of Jonathan Woodbridge Buys, received earlier this month.

The Boiler Sub Committee is keen to update their records of boilers owned by Club members and are seeking current information from members to enable this to occur. Would you therefore advise the Secretary of which boilers you currently have and some brief details (boiler number and what type/name, etc.) so he can check them off in the Club's records.

The Club's mid-year luncheon was held on Saturday 16th July – our numbers were a little low at 24 but it was decided to proceed anyway. Part of our consideration was that we

have booked the same caterer for Christmas and we didn't wish to cancel at short notice in case he felt we were unreliable which might have put our December booking at risk. It turned out to be a nice sunny day and with the ladies along, some social time and a nice two course dinner, it was a most enjoyable occasion. Thanks to Timothy Robinson and Dave Russell who turned up early to set up the Clubhouse and to Ann Emerson who prepared some lovely flower arrangements for the tables. Please ensure you have the date for the Xmas Dinner noted down in your diary, so that we can be assured of a better turnout for the next social event.

At the track, we are looking at some work on the overpass bridge and some re-grading of the smoke box curve. Together with preparations for the Annual Exhibition, this will necessitate a working bee in September. A suggestion that we try a Sunday morning to see if we can get a better turnout was made at the last general meeting, so watch this space for advice of the exact date!

Are you making use of the ASME Library? The librarian has added several new books and some DVDs to the collection this year and of course all the old favourites and ME magazines are there for reference or to be borrowed from one general meeting to the next – see Alan G or Tony L at the next meeting.

I hope you are giving some thought as to what exhibits you can make available to display, and what help you can provide for supervision and railway duties, at the ASME Annual Exhibition weekend to be held on Saturday 8th & Sunday 9th October. We will be looking for entries and volunteers soon, but in the meantime if you have any queries, please see our chief organiser, Bill Parker.

We are still looking for some “inventive” members to prepare the Club's entry in the Les Moore Challenge at the “Steam Up North” Convention to be held in January next year. If you require a copy of the rules, I now have these and can forward for your consideration – just let me know.

Stay warm and dry!

Grant Anderson

19th July 2011

Bits & Pieces

General Meeting, 5th of July 2011

Hosted by Peter Woodford, reported by John Olsen

Graeme Murray brought his completed toggle action press. [Photo A](#), This reaches inside a rectangular extrusion to make notches to retain printed circuit boards. The boards are part of a control system for a water diverter for rural water supplies. When it starts raining, the first flush of water is used to backflow through a filter and is dumped, if it keeps on raining the water is filtered and passed on to the tank. He also brought some parts for a filter wheel for a very top end scientific camera. It apparently costs a lot of Euros for a filter wheel that allows interchangeable filters, so Graeme has made one. Some very nice thin shim stock has been machined on his CNC machine by sandwiching it with support stock. The result looks as good as laser cutting. [Photo B](#) Finally Graeme brought a modified soldering iron and a jig for joining plastic belt stock. He demonstrated this over supper to those interested. These belts can be used on smaller machines like Unimats, although I found that converting the little machine to toothed belt drive was a much better solution. [Photo C](#)

Mike Jack had a section of aluminium bar machined to a three lobed profile. This turned out to be the stock for Allan Foster to make the Rootes type blower for his Commer TS3 Diesel engine from. [Photo D](#)

Ron Copeland donated two bags of red fibre washers.

Bill Parker brought along the cylinder block for a King class locomotive in 7-1/4' gauge, a lovely piece of casting. [Photo E](#)

Dave Russell has made a pair of tool holders for small tips to use with the Myford, very nicely made. [Photo F](#)

A tapping guide has been made by Greg Burrows using CNC, and it is easy to get the name right here since it has been machined into the side of the arm. This sort of device can save a lot of small taps. [Photo G](#)

Peter Woodford showed us polystyrene in several guises, eg the commonly seen expanded form as used for packing, some disposable utensils made of normal polystyrene, and the high density form that he works with in the form of test pieces. He often brings the latter along in quantity and they make excellent glue sticks and paint stirrers, at least so long as the paint does not dissolve them. I have used a few of them on epoxy!

MBM models showed a nice mechanical lubricator using a sprag clutch. I understand they can supply these. [Photo H](#)

Graeme Bell has experienced some clinkering with the Australian char as used by the club, despite the belief of some that it does not clinker. Clinkering occurs when the temperature in the fire bed gets hot enough to fuse the ash content. So for clinkering to occur there must be ash content in the fuel, and the temperatures must get pretty hot. It often occurs when a small fire bed has to be driven hard. One solution in full size practice is to inject a small amount of steam into the air supplied through the ash pan.

A pair of excellent rods for a five inch gauge Britannia were the work of Mike Jack, produced with CNC to his usual high standard. These are very close to scale in all dimensions including the web thickness. [Photo I](#)

A small Yarrow boiler is the work of Hugh Martin. [Photo J](#) He also had a small generator he has purchased for the completed plant to drive, [Photo K](#) along with a steam pressure controlled gas valve and a ceramic block burner. This is all for a generating plant to keep the grandchildren amused. He also had a set of Stuart Turner castings for a feed pump, as yet un-started. [Photo L](#) So it looks like there will be plenty to amuse Hugh for now in the workshop, as well as the grandchildren later.

A locomotive wheel was brought along by our President Grant Anderson. He found that only about 7% of the weight of the coupling rods was being balanced, so has lightened the rods and added a lot of lead to the wheels. It still does not balance all of the rotating mass, let alone trying to balance the usual proportion (about 2/3) of the reciprocating masses. It should be better than it was. [Photo M](#)

Greville Wills has been overhauling "Smokey" who is 28 years old. The cylinders he brought along have been bored and lined, and the valve faces have been faced on a surface grinder. [Photo N](#) Greville is also making a blower, or rather a sucker since it goes on the chimney, for starting a locomotive fire when there is no compressed air supply. It has a speed controller to control the draft. [Photo O](#)

Finally a cloth badge was on display, if you would like one to sew onto your overalls or cap see Hugh Martin.

John

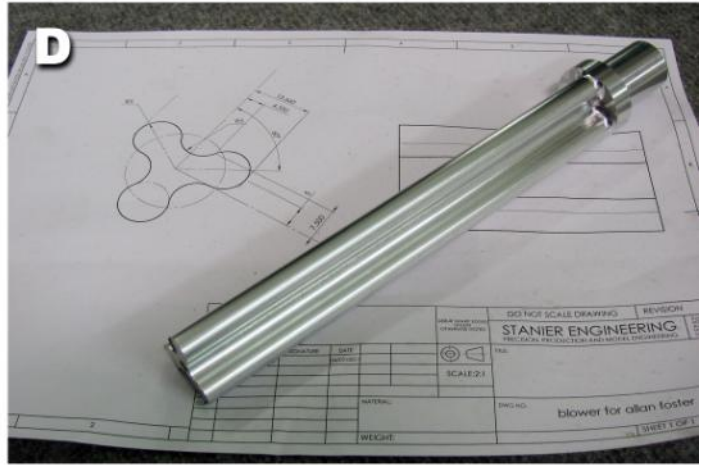
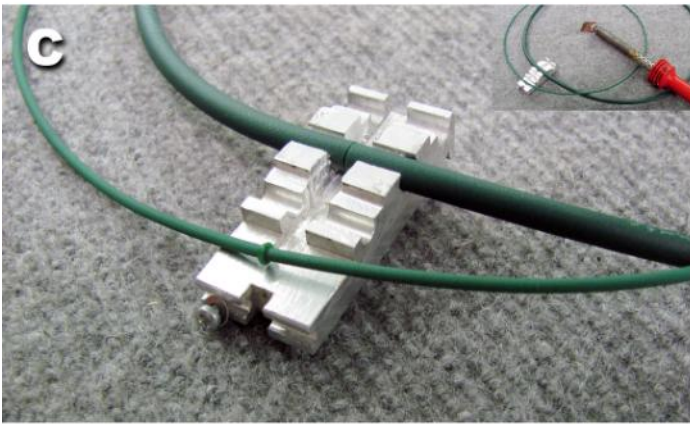

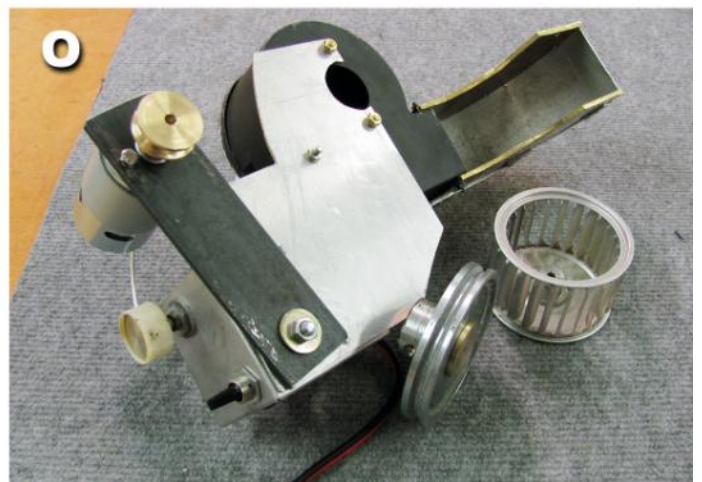
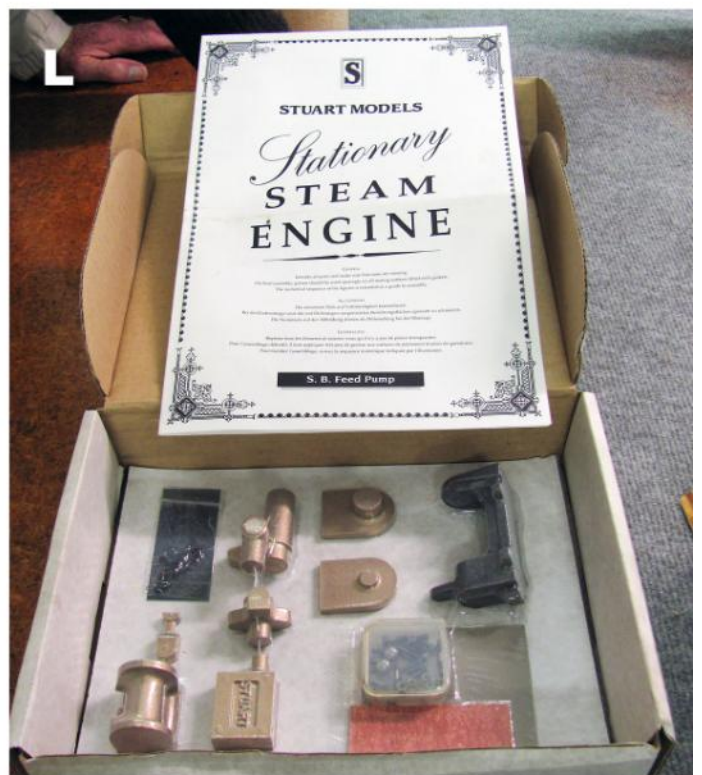
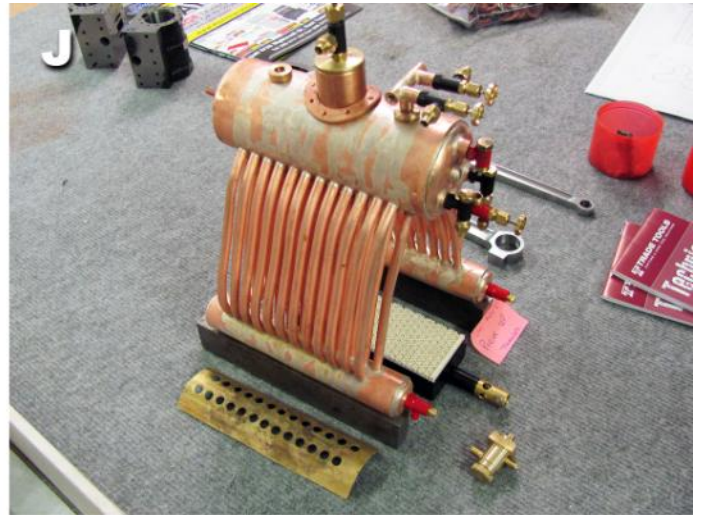

Latest in Engineering

Extracts from The Model Engineer and Electrician of July 27, 1911.

The New National Model Experimental Tank

On Wednesday, July 5th, some two or three hundred ladies and gentlemen visited the National Physical Laboratory at Kew, at the invitation of Sir Archibald Geikie, K.C.B., and the Right Hon. Lord Rayleigh, O.M., F.R.S., on the occasion of opening the new tank. A special train leaving Waterloo at 3.5 p.m conveyed the visitors to Teddington, and vehicles were in attendance at the station. The party went at once to their seats in the tank building.

Sir Archibald Geikie occupied the Chair, and opened the proceedings. Then Lord Rayleigh addressed the meeting on the subject of the tank, alluding to the generosity of Mr. A. F. Yarrow, who ten years ago proposed that an experimental tank should be established, and subsequently presented the handsome sum of £20,000 for the construction of the tank and buildings. The Institution of Naval Architects and the Executive Committee of the Laboratory provide the necessary funds for working the tank.

There are two tanks, contained in an excellent building, light and airy, the roof being of the saw-tooth type, the glass facing the north. The large tank is 550 ft. long by 30 ft. wide, and has a depth of 12 ft. 3 ins. It is constructed of concrete, and has on the top of each side wall a steel rail, planed on the top and on both sides, and most accurately laid as to level and straightness.

The travelling carriage is massive, weighing 14½ tons, requiring four 35 b.h.-p. motors to give it a sufficiently rapid acceleration when being used at the maximum speed of about 17 m.p.h. An elaborate electric control is provided both on the carriage and on shore, the electric energy being derived from 55 cells of 1,000 ampere-hours each, and being transmitted to the carriage through sliding contacts running on six parallel conductors fixed against the west wall. At the end of its journey the carriage is automatically stopped, both ordinary and emergency brakes being provided. The effect of an "irresistible body" weighing 14½ tons travelling at 17 m.p.h. and coming into sudden contact with an "immovable stop" would be too awful to contemplate.

Now all this elaborate and costly apparatus is to be used for what purpose? Simply to drag through the water a paraffin-wax model of a vessel weighing at the most but a few hundredweights, and in many cases not weighing anything like so much. The great weight of the carriage, and the accuracy of the path upon which it runs ensure extreme steadiness of motion, without which the indications of the very delicate means of measuring the velocity and the tractive force would be irregular and unreliable.

The wax model, which may be anything from 14 ft. to 20 ft. long, is towed underneath the travelling carriage between travelling guides, which ensure a straight course, and very interesting it is to watch the formation of the waves which proceed from the model at constant speed, and the intersecting diagonal wavelets which continue to travel from both ends of the tank, crossing each other without interference, for a long

time after a double trip has been accomplished.

Our readers may ask "But what, after all, is the practical use of this expensive apparatus"? Well, briefly described it is this: If an accurately made scale model of the hull of a large vessel, say an Atlantic liner or a battleship, or indeed of any craft whatsoever, be towed through the water at a speed which is the speed of the prototype multiplied by the square root of the scale the stress on the tow rope of the model will be as the cube root of the scale, subject to a correction for skin friction, and the formation of waves in terms of the length of the model will be the same as the formation of waves in terms of the length of the prototype.

In the same building is a smaller tank 63 ft. long, 5 ft. wide, and 3 ft. 3 ins. deep. At one end is a rotary pump capable of driving through the tank 75 cub. ft. of water per second. A motor of 82 b. h.-p. drives this pump. Stationary models can, in this tank, be studied, when floating in flowing water, the velocity of which is known. Experiments with screw propellers will also form the subject of investigation in these tanks.

The making of the wax models is very interesting. Rough castings in paraffin wax are first made by running wax into clay moulds. The rough models are then subjected to a revolving cutter, which, guided by suitable profiles, cuts horizontal grooves in the wax to the correct outlines. The intermediate portions of the wax are then trimmed down by hand until only the finest traces of the grooves are left. After tests have been made with models so prepared, they can be melted down again, and the wax can be used for making other models.

The tanks were designed by Dr. R. T. Glazebrook, C.B., F.R.S.; the consulting engineers were Messrs. Mott & Hay, of Westminster; and the contractors were Messrs. Dick, Kerr and Co. Ltd.

Brian Cotton

Around the Clubs

August 2011

Model Torque , Napier , May 2011.

All seems to be going well, the preparations are under way for their 50th Anniversary in Feb 2012. Interesting observations from a new member. A write up on a very strange low flying Russian aeroplane. The Maid of Kent more or less back in working order.

Big Wheel News , Victoria , May/June 2011.

Pictures of two Gauge 1 radio controlled and gas fired locos, made in China. Photos of the Club activities including a photo of a loco with wind up key sticking out of the side. Visit to the AALS Convention at the Lake McQuarrie Live Steamers Park. From the photos the site looks massive, Caters for everything from garden gauge to traction

engines. A 3 ½" and 5" raised track and ground level 5" and 7 ¼".

Steamers and Dreamers , Manukau , June 2011.

Visit to the Thames Queens Birthday Weekend enjoyed by a number of MLS members and others. 30 year Celebration Weekend went extra well despite poor weather on the Saturday. The fine weather on Sunday and Monday encouraged a big turnout of passengers. The Dinner at Butterfly Creek a great success, a great meal, slide show and a look at the crocodiles. The Family day on the 2nd July was a good chance to drive other locos on another track, lot of fun and a very nice lunch too.

The Keirunga Park Platform , Havelock North , Winter 2011.

Cover photo of a model 14 cyl 2 row radial aero engine. It runs on petrol and has spark ignition, swings a 12" prop. Built by Dennis Fadden of Canada, a real watchmaking job. Reminder about their 20th Birthday coming up next Easter [April 6-9 2012]. Photo and story about Swiss trains. Photos too of 2 miniature engines, a little V8 and a Russian aero V8 of 4cc

Blast Pipe , Hutt Valley and Maidstone , July 2011.

Cover photo of a beam engine built from plans taken off the internet. Club photos showing a new trolley bogie, some CNC milled gears, round and square, action around the track and a BVBaker loco for sale. The raised track to be replaced in concrete. The contractor is to use a modified kerb laying machine. Visit to the MLS Queens Birthday Weekend.

Conrod , Otago , June 2011.

Good Club news covering all the sections. The Engineering group are to run a beginners course to build a tether car. The story and photos of the Raurimu Spiral. A good read.

Northern Views , Whangarei , June 2011.

Photo and problems with the new Peppercorn Loco. Problems with the new Chinese high speed trains. Some good photos of the track improvements, a restored GWR loco and damage to the track when the intermediate loco doesn't stop.

Expansion Link , Hamilton , June 2011.

Good track shots of the track in action. Some thoughts on safety and an article on the sad train crash at Cleveland Park.

The Generator , Palmerston North , May and June 2011.

The cover photos show a very nice new Mountaineer and a driving truck to go with it. The two Letters From England are well worth a read as they cover all manner of subjects.

Well worth a read too is the story of the Packard built Merlin engines. Write up on the Wanaka Museum, certainly worth a visit. Stan Compton also produced the story of Des O`Bryan, very interesting. For Tender a Stuart Turner set of Casting and parts.

Wheels and Floats , Tauranga , June/July 2011.

Musings from the roving reporter, action photos from the track and some funnies.

Mailship , April 2011.

The story of HMNZS Tui. Pool News and the Hutchwilco Boat Show

Blowdown , Kapiti , Winter 2011.

Photos of the progress on the new track. Warning on the use of Viton O rings

Engine Booster , Los Angeles , June 2011.

Sad to note the passing of three valuable members. Great selection of photos on the back cover.

Slipstream Auckland Model Aero Club , May 2011.

All you wanted to know about model planes, including half size plans and cutaway views of engines.

Melsa , Maryborough . June 2011.

Photos of a great model of a Cobb and Co coach. Selection of photos from the Track and from Tasmania. Article and plans for a tailstock 6 position turret.

Alan E.

Classifieds

For Sale

The following workshop items are for sale:

- | | |
|--|-------------------|
| 1. Paasche H Set Airbrush Set little used, a very good quality tool | \$70 |
| 2. Dial Indicator 0-10mm .01 mm grad. | \$35 |
| 3. Magnetic Base with fine adjustments | \$40 |
| 4. Micrometers outside 25-50 mm 0-25mm carbide faces ratchet stop | \$45 (the pair) |
| 5. Machine vice Swivel base 80 mm open | \$40 |
| 6. Lathe Carriers Small, .Medium, Large | \$35 |
| 7. Jacobs Industrial Chuck and 3MT Arbor to fit | \$50 |
| 8. Live Steam Magazines 1987 - 2001 @ 25 cents /magazine will keep you in projects
For the rest of your life! | \$29.50 (the lot) |

Contact John Harrison Ph: (09) 480 6638

Casting Operations

A "K" LOCOMOTIVE FRAMESTAY IN THE MAKING.
(By W. D. BURTON, Works Manager, Hutt Workshops.)

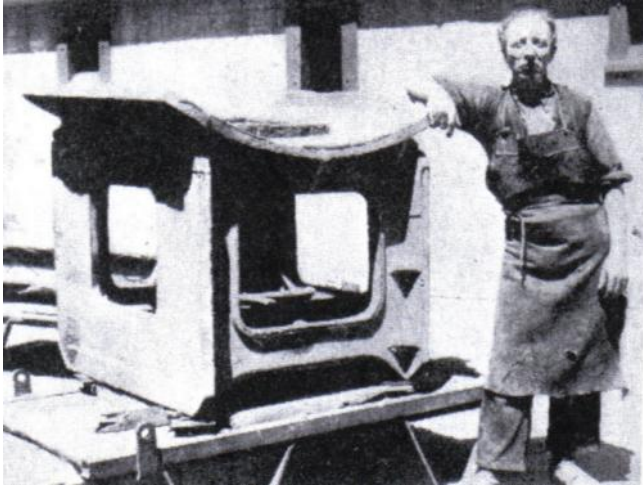

Casting Ready for the Machine Shop.

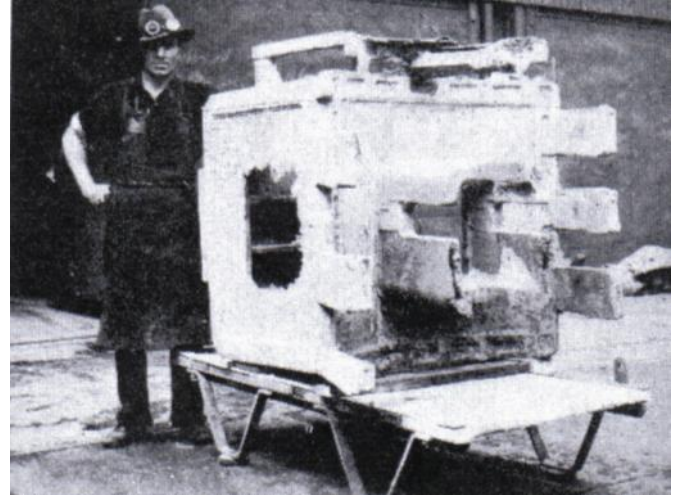

Casting Just Out of Sand.

The locomotive framestay is an important casting which supports the sides of the locomotive frame and the smokebox. If this casting is to pass its tests successfully, and stand up to its subsequent work in service, it must be fabricated from the highest quality of steel. Paradoxical as it may seem, the steel required for the purpose is manufactured from scrap and waste material from the engineering shops, the process being rendered possible by the use of the modern electric steel-making furnace.

Preliminary Work.

How does it come about that the scrap material referred to is transformed into the first-class casting of the highest quality steel, shown in the illustrations accompanying this article?

In the first place plans of the casting are made. From these plans a model, exact in size and detail to the original design, is made in wood. The model is called a pattern, and is the work of the patternmaker. The pattern is then placed in the sand until a perfect imprint of it is obtained. This work is carried out by moulders, who reinforce the sand with nails, treacle, and fine silica flour, until it is strong enough to stand the ravages of molten steel, which will surge in later and fill every nook and cranny.

Now for the steel, which will compose the casting. Since it requires to stand up to certain loads and vigorous treatment in service, the steel must be strong and ductile. The prescribing of the steel is the work of the chemist, who juggles with the carbon, sulphur, phosphorus and other ingredients until a preconceived arrangement is reached, thus guaranteeing that the steel will stand up to its tests.

All is now ready for the casting, in conjunction with which test bars are cast. These bars are later removed and tested before the process of completion of the casting is taken to a further stage. After the casting of the steel, the mould is all owed to cool

off, and the sand is then knocked away, leaving the casting as shown in the illustration (right). The total weight of the casting as shown, with runners and risers complete, is 28 cwt.

The runners and risers are used to balance the "draw" of hot metal. The metal contracts in cooling, and the skilful allocation of the runners and risers prevents the casting from cracking.

Testing and Finishing

The tests of the steel in the case of the framestay shewn in the illustration, came out as follows:

C	S	P	Si	Mn
.35	.038	.037	.2	.75

Yield stress: *20 tons per sq. in.*

Ultimate strength: *35 tons per sq. in.*

Elongation: *27%*

Reduction in area: *39%*

The steel also withstood cold bending through 1800 degrees F without signs of fracture. Altogether the steel was a high grade article, and met the rigorous specifications which guarantee efficiency and safety.

From the analytical data, the chemist was able to prescribe the temperature at which the casting was annealed, which was 15800 degrees F maintained for a period of ten hours. The annealing brings the casting to its full strength and ductility, and gives it good machining properties not possessed by un-annealed steel.

After annealing the casting must be fettled and dressed ready for machining operations. This process, quite a problem in itself, involves the removal of the runners and risers, which in this case weighed 6 cwt.

The economical removal of the runners and risers is made possible by the modern invention of the oxy-acetylene flame, which cuts through the unwanted masses of steel like a spoon through custard.

The cleaning of the casting is another problem, happily and cheaply overcome by the sand blast method. An operator, protected by helmet, goggles, a strange protective uniform and high boots, and breathing from an airline from a supply of pure air, looks like an apparition from another world as he approaches the casting with a gun which shoots a stream of sand at high velocity. The casting is thus cleaned quickly and efficiently.

After the cleaning operation the casting weighed 21 cwt., and was handed over to the machinists, who perform skilful surgical operations on the casting until its size and form is perfect to the original design. The casting is then handed over to the erectors who, with every confidence, put it in its destined position on the new locomotive. "She's a good job, that framestay," said the men who handled it, and the inspectors who approved it.



An Ab Locomotive on the Turntable at Auckland (Photo W. W. Stewart)

Notes From the Editor's Desk

Newsletter Delivery

If you wish to continue to receive the newsletter by post, you must contact the secretary in writing to advise as such. The newsletter you receive in the post will, in the near future, be black and white only.

Boilers

Anybody who owns a boiler which is subject to club rules needs to contact the secretary stating that they still own/use that boiler. The reason behind this is the committee would like to cull the long list of boilers on its books - as many have now long gone, or even gone overseas.

Library Books

The club has purchased some new and interesting books for the library, which are now available for borrowing - get in quick before they are all gone!

Club Website

For those that do not know the login details for the club website, or have trouble logging in, please email the editor at editor.asme@gmail.com.

Please note you are no longer required to login to download the newsletter, these are now in the public domain. Find them here: www.asme.org.nz/newsletter.aspx

You are most welcome to send the editor any content you think may be suitable for the club website, such as photos or a brief history, to the following email address:

editor.asme@gmail.com